



**DOWNLOAD COLOR
INSTALL MANUALS AT
www.bddiesel.com**



Dodge Venom Dual Fuel

5.9L & 6.7L Cummins Dual CP3 Kit





Below Kits Contain 'Y' wiring Harness





1050475	2005-09 Dodge Ram
1050476	2005-09 Dodge Ram W/O CP3*
1050477	2010-12 & 2015-18 RAM
1050478	2010-12 & 2015-18 RAM W/O CP3*
Below Kits Contain Dual CP3 Controller	
1050485	2005-09 Dodge Ram
1050486	2005-09 Dodge Ram W/O CP3*
1050487	2010-12 & 2015-18 RAM
1050488	2010-12 & 2015-18 RAM W/O CP3*

BD Monster Line Kit (1050331), or equivalent 1/2" fuel hose kit is required.

*Kit to be used with Duramax style CP3 pump.





Common Kit Contents			
1500701	1500708	1500710	
			
Dual CP3 Bracket Qty: 1	CP3 Drive Pulley Qty: 1	High Pressure Fuel Line Qty: 1	
DAY89094	1500680	1500681	
			
Idle Pulley Qty: 1	CP3 Input Fitting Qty: 1	CP3 Output Fitting Qty: 1	
1500464	1500682	FT-99165919	1500416
			
Fan Shroud Support Qty: 1	Fan Shroud Spacer Qty: 1	2-1/4" CLAMP Qty: 1	-6JIC X M12 Qty: 1
1502033	1500417	1502040	1502038
			
-8JIC X M12 Qty: 1	-6JIC x 3/8" Hose Qty: 1	M12 x 1/2" Hose Qty: 2	-8JIC x 1/2" Hose Qty: 1
FT-441331	1502017-Z	1130165	1452821
			
1/2" Hose Tee Qty: 1	Banjo Bolt Qty: 1	3/8" Hose x 1/8"NPT Qty: 1	1" Clamp Qty: 4

1505001	1604054	1604053	FT-11116108
			
5/8" Clamp Qty: 2	1/2" Hose Qty: 30"	3/8" Hose Qty: 30"	Bolt M8x45 Qty: 3



FT-11116245	FT-11115676	1900014	FT-MJ2740000ZP00
			
Bolt M8x25 Qty: 1	Bolt M8x50 Qty: 4	Nut M8 Qty: 7	Jam Nut M18 Qty: 1

1302110	1502019	1402609	FT-11115670	FT-11115722
				
Washer M18 Qty: 1	M12 Seal Washer Qty: 4	Washer M8 Qty: 1	Bolt M8x20 Qty: 3	Bolt M8x16 Qty: 1





Kits 1050475 & 1050476 (CP3 Pump Only In 1050475**)**

GATK081369HD	1500461	1500722	0986437332**
			
Serpentine Belt Qty: 1	Upper Rad Hose Qty: 1	CP3 'Y' Harness Qty: 1	CP3 Pump Qty: 1

Kits 1050485 & 1050486 (CP3 Pump Only In 1050485**)**





GATK081369HD	1500461	1050455	0986437332**
			
Serpentine Belt Qty: 1	Upper Rad Hose Qty: 1	CP3 Control Module Qty: 1	CP3 Pump Qty: 1

Kits 1050477 & 1050478 (CP3 Pump Only In 1050477**)**

GAT38053	GATK081348HD	GATK081369HD	1500722
			
Idler Pulley Qty: 1	Serpentine Belt Qty: 1	Serpentine Belt Qty: 1	CP3 'Y' Harness Qty: 1

1500462	FT-776768	FT-0152661	0986437332**
			
Upper Rad Hose Qty: 1	3/4" Insulated Clamp Qty: 1	Washer 3/8" Qty: 1	CP3 Pump Qty: 1

Kits 1050487 & 1050488 (CP3 Pump Only In 1050487**)**

GAT38053	GATK081348HD	GATK081369HD	1050455
			
Idler Pulley Qty: 1	Serpentine Belt Qty: 1	Serpentine Belt Qty: 1	CP3 Control Module Qty: 1

1500462	FT-776768	FT-0152661	0986437332**
			
Upper Rad Hose Qty: 1	3/4" Insulated Clamp Qty: 1	Washer 3/8" Qty: 1	CP3 Pump Qty: 1

Suggested Optional Items

Add the following products to make the most of your *BD Venom Dual Fuel Kit* performance! Visit our website www.bddiesel.com for more info!



<p>1050370 (2003-2009) 1050371 (2010-2018)</p>	<p>1050305DF (2003-04.5) 1050310DF (2005-09) 1050311DF (2010-12) 1050313DF (2013-19)</p>	<p>1050331</p>
		
<p>Fuel Distribution Block</p>	<p>Flow-Max Lift Pump</p>	<p>Monster Line Kit</p>
<p>Qty: 1</p>	<p>Qty: 1</p>	<p>Qty: 1</p>

Table of Contents

Common Kit Contents	2
Kits 1050475 & 1050476	3
Kits 1050485 & 1050486	3
Kits 1050477 & 1050478	4
Kits 1050487 & 1050488	4
Suggested Optional Items	5
Table of Contents	5
Introduction	5
Operation	6
Tools Required for Installation	6
Installation	6
For kits containing 1500722 – CP3 ‘Y’ Harness	15
For kits containing 1050455 – Dual CP3 Control Module	16
Troubleshooting	18
Kit Layout & Wiring Diagrams	19

Introduction

The factory high-pressure CP3 pump found in common rail Cummins applications can support up to ~500 wheel HP. Beyond that point, rail pressure will start to drop off at wide open throttle, causing loss of performance.

The *BD Dodge Venom Dual Fuel Kit* allows 5.9L and 6.7L Cummins owners to push past 500 HP, by adding a second high-pressure fuel pump. This kit mounts a Bosch CP3 (Duramax style CP3) to the engine and increases the high-pressure fuel flow volume available.

Operation

The *BD Venom Duel Fuel Kit* splices into the feed and return hoses of the factory low-pressure fuel system to supply fuel to the additional high-pressure CP3 pump. This second CP3 ties into the high-pressure fuel system, and supplies the additional fuel required by high horsepower applications.

Tools Required for Installation

- T50 Torx Bit
- Torque Wrench
- Socket Set
- Wrench Set
- Side Cutters
- Screwdriver Set

Installation

Disconnect both vehicle batteries before installation for safety.

Drain coolant from radiator and remove upper radiator hose. Save radiator hose clamps for use later.

Note Only enough coolant needs to be drained to remove the upper radiator hose.

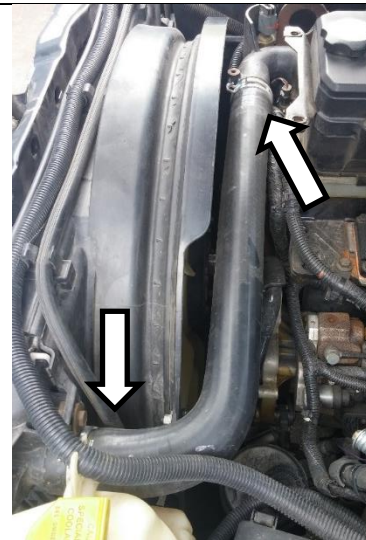

Remove serpentine belt by turning the tensioner clockwise using a ½" drive ratchet and pulling the belt off of the upper idler pulley.

This belt can be discarded, as it will be replaced later.

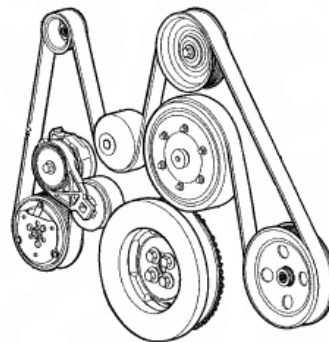

Remove the factory fan-shroud support bracket (if equipped).



Using the T50 Torx bit, remove plug from lower driver's side rear of original cp3 pump in the truck.

Note when removing the plug, be sure to not misplace the ball bearing contained by the plug and spring. It may fall out during removal.

CP3 shown lower right removed from truck for clarity.

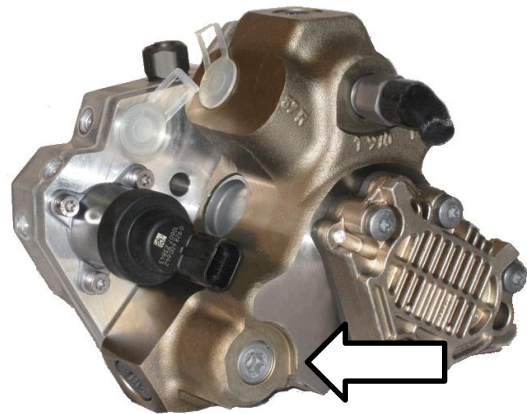
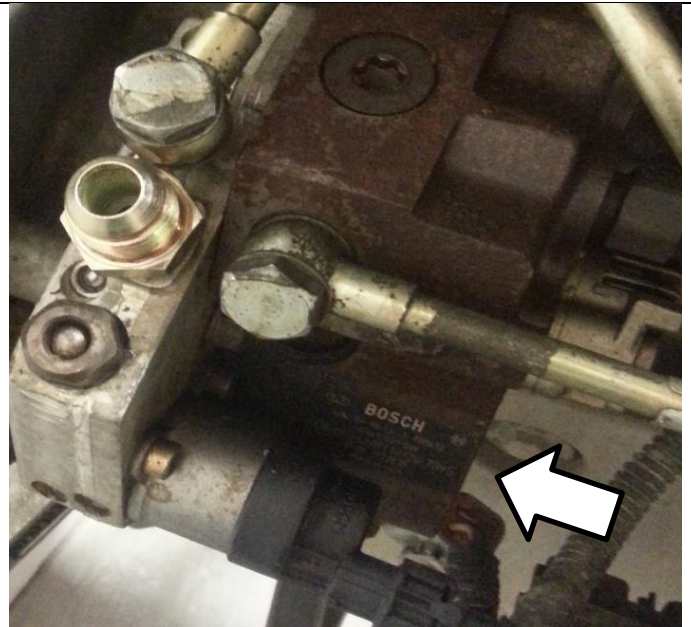

Transfer spring from plug to the supplied high-pressure fitting (PN 1500680) as shown.

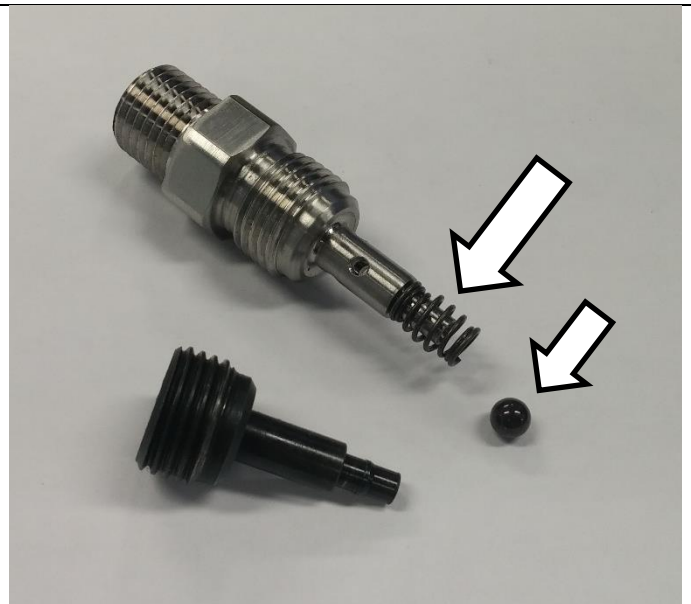

Reinstall ball bearing and supplied fitting assembly into port where plug was removed.



Note Ensure ball bearing is inserted completely into bore before inserting the fitting. Failure to install ball bearing can result in damage to injection system!

Torque fitting to 56 ft-lbs

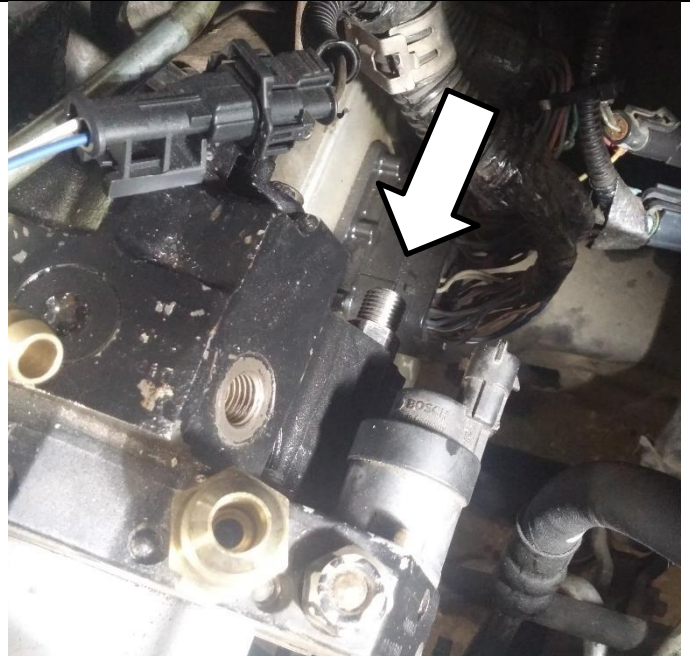

5.9L Trucks: Remove feed line and fitting from the factory CP3 and install supplied -8JIC fitting (PN 1502033).

6.7L Trucks: Remove feed line and fitting from factory CP3 and install supplied 1/2" barb fitting (PN 1502040) using seal washer supplied (1502019).

Above right: 5.9L truck
Below right: 6.7L truck

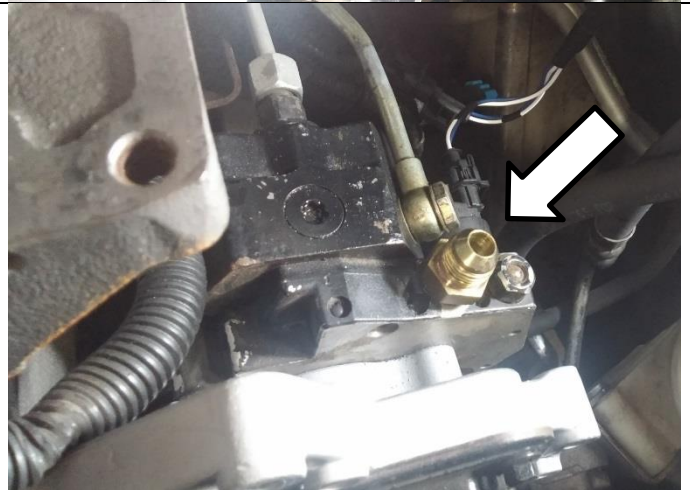

5.9L Trucks: Install supplied -8JIC swept fitting (PN 1502038) into the low-pressure fuel feed line using supplied gear clamp. Connect this to the feed fitting installed in the previous step.



6.7L Trucks: Install low-pressure fuel feed line onto previously installed hose barb using supplied gear clamp.

Assemble the supplied 3/8" barb x 1/8" NPT (PN 1130165) into the banjo bolt (PN 1502017-Z) using some thread sealant.



Remove factory return banjo bolt and replace it with the banjo assembly put together in the previous step.

Note this step can be skipped if using a fuel distribution block.

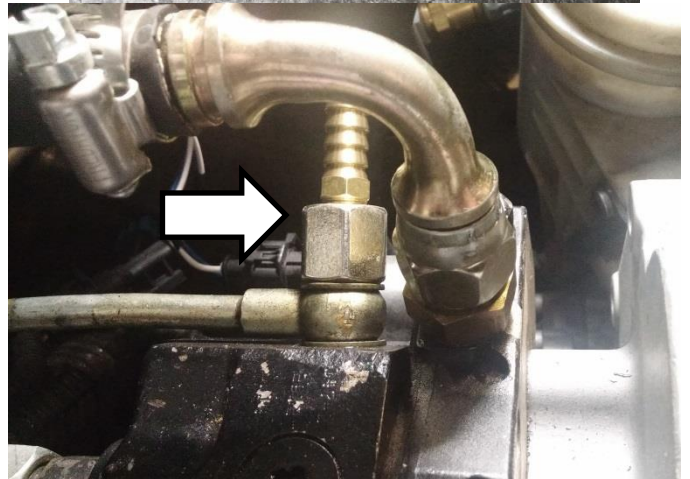

Mount the new CP3 pump to supplied bracket using the supplied three (3) M8x45mm bolts, and M8 flange nuts.

Note Pump to be oriented with metering unit and ports pointing upwards (See image).

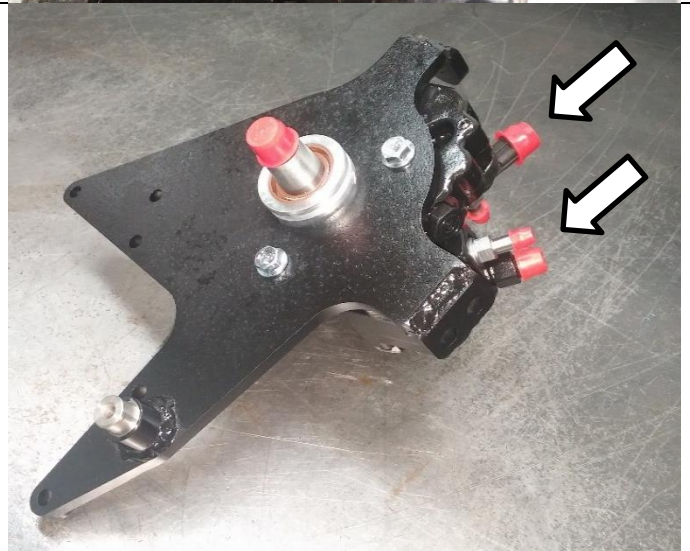

Mount pump and bracket to engine, using one (1) M8x25mm bolt and four (4) supplied M8x50mm bolts with four (4) flange nuts.

Note The single M8x25mm bolt (see star arrow) will screw into an existing threaded hole in the timing case. This can be used to position the bracket while installing the other fasteners.

Torque bolts to 25 ft-lbs

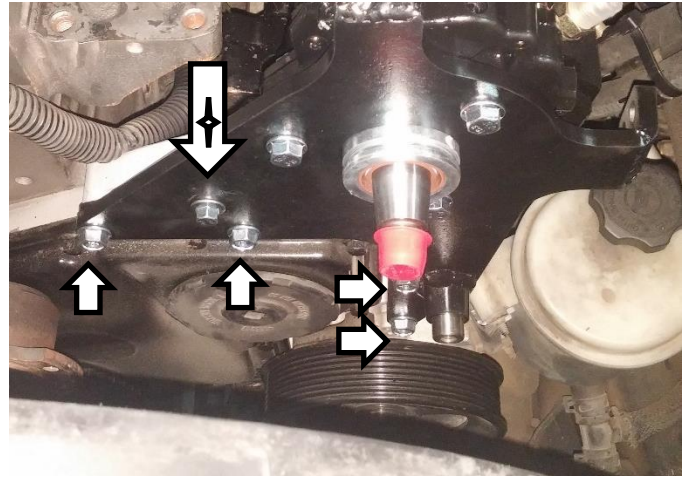

Install smooth idler pulley onto CP3 bracket, with supplied m8 washer (1402609) and M8x16mm bolt.

Torque bolt to 20 ft-lbs



Install CP3 Drive pulley onto pump, using supplied M18 Jam nut and flat washer.

Torque to 75 ft-lbs

(Fan shroud shown removed for clarity)



If installing kit onto a 2013+ model year truck, the supplied small ribbed idler pulley (PN: GAT38053) will need to be installed.

Install this pulley with the supplied fender washer (PN: FT-0152661) and re-use the factory bolt. Discard the factory washer/shield.

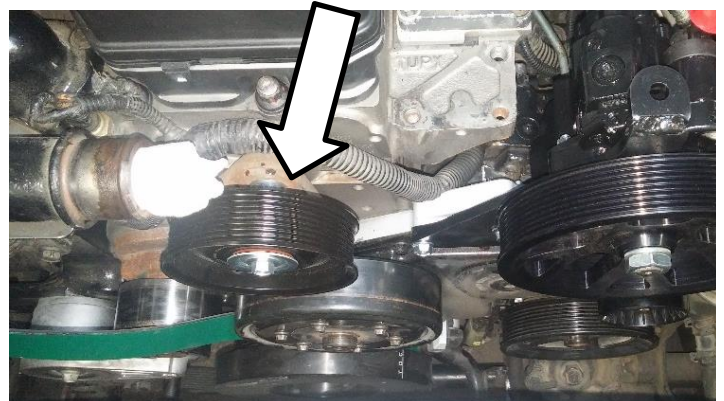

Install supplied serpentine belt as shown.



Important Note

2003-'12 trucks use **K081369HD**
2013+ trucks use **K081348HD**

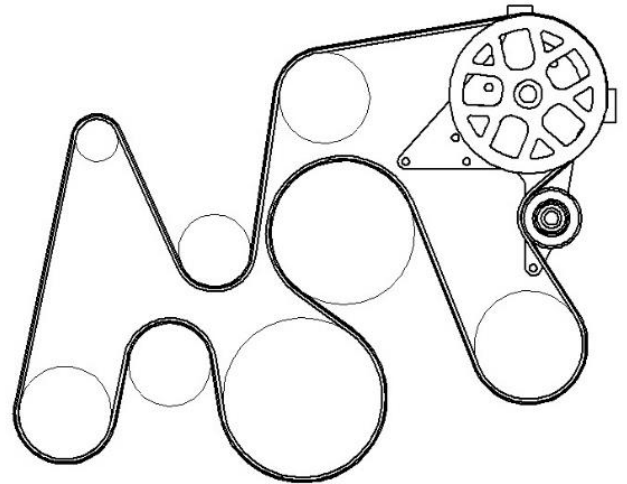

Install high-flow hose fitting (PN 1502040) into CP3 pump inlet, using seal or washer found on oem fitting supplied with pump.

Torque to 6 ft-lbs. Do not over-torque. High-flow fitting is thin wall and may fracture if over-torqued!

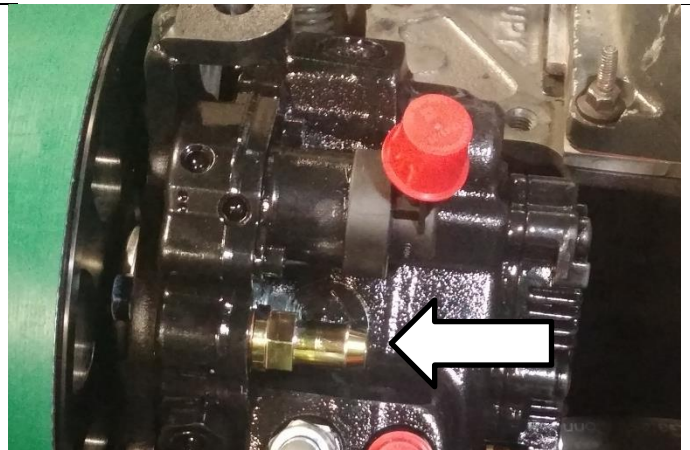

Install -6 JIC fitting (PN 1500416) into the return port of the CP3 as shown. Using supplied seal washer (PN 1502019).

Torque to 18 ft-lbs



If installing this kit onto a **6.7L** equipped truck:

Replace the high-pressure output fitting on the second CP3 with the supplied fitting (PN: 1500681).

Torque fitting to 56 ft-lbs



Insert supplied -6 swept JIC fitting (PN 1500417) into the supplied 3/8" return hose, using supplied gear clamp as shown.

Attach hose to the -6 return fitting of the second CP3 pump, and the other end to the hose barb previously installed onto the factory CP3 pump. Trim hose to desired length before final install.

Note If using a fuel distribution block, the return hose will be routed to the return port of the block, instead of the original CP3.

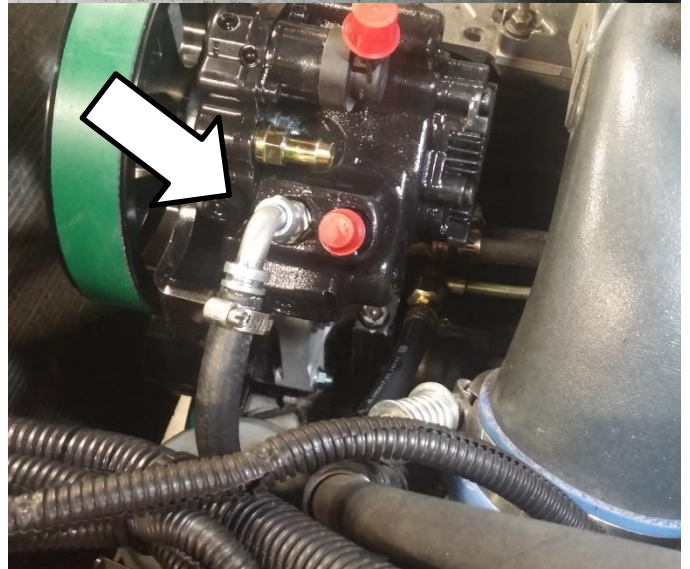

Insert 1/2" tee into the 1/2" fuel hose supplied using a gear clamp.

Cut low pressure fuel hose feeding the original CP3 and insert the assembled tee and hose.

Clamp the joint using supplied gear clamps.



Note If using a fuel distribution block, connect the fuel hose to the supply port of the block instead of splicing into feed hose.

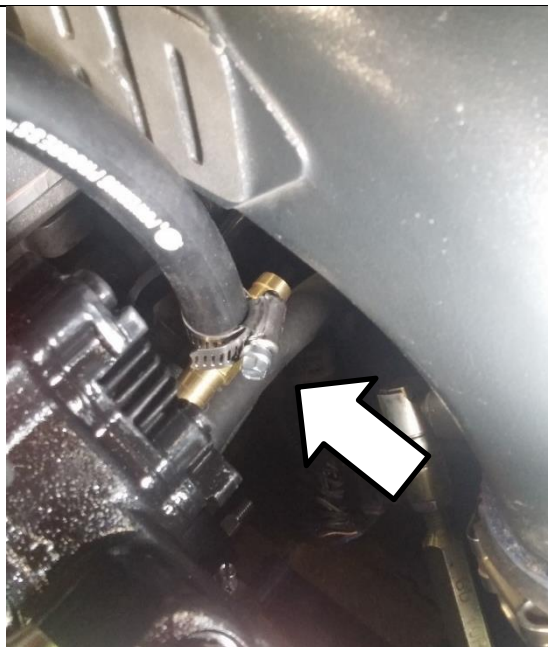

Trim the hose to desired length and attach to the 1/2" feed port on the second CP3 pump.

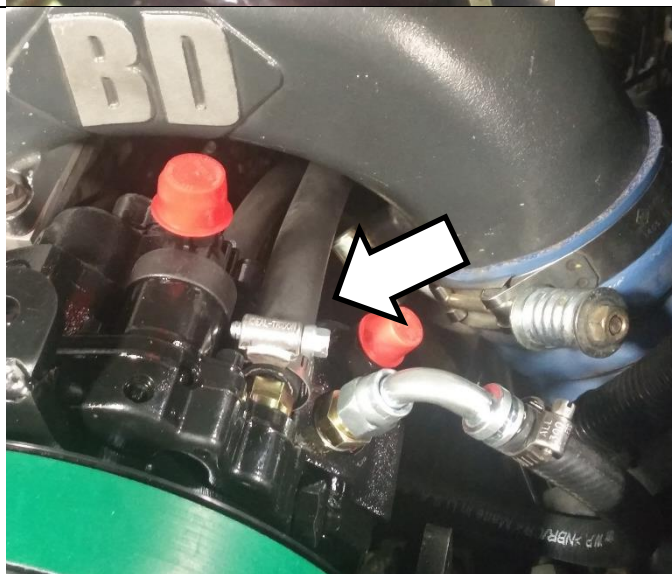

Install high pressure fuel line between the installed fitting on the back of the original CP3, and the high-pressure output port of the second CP3 as shown.

Torque high-pressure line to 30 ft-lbs.

Note Removing the intake horn can aid in installation of the high-pressure fuel line.

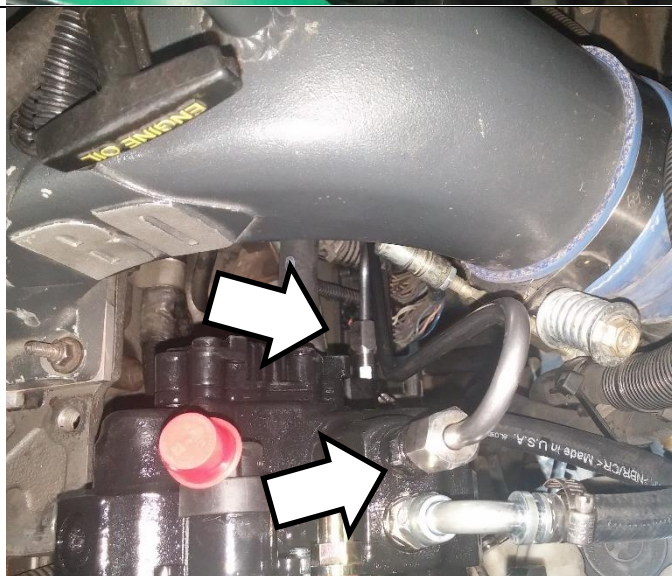

Acquire supplied fan shroud bracket, and shroud spacer, and assemble as shown above right.

Assemble bracket with spacer onto the CP3 bracket with supplied M8x20mm bolts and reuse the factory nut to secure the fan shroud to the new bracket.

Note 3rd gen (2003-09) trucks will use the forward pair of holes for mounting (as shown), and 4th gen (2013+) trucks will use the rearward pair of holes.

Note 2010-2012 trucks will not have the requirement for this fan shroud bracket, and it will not be installed.

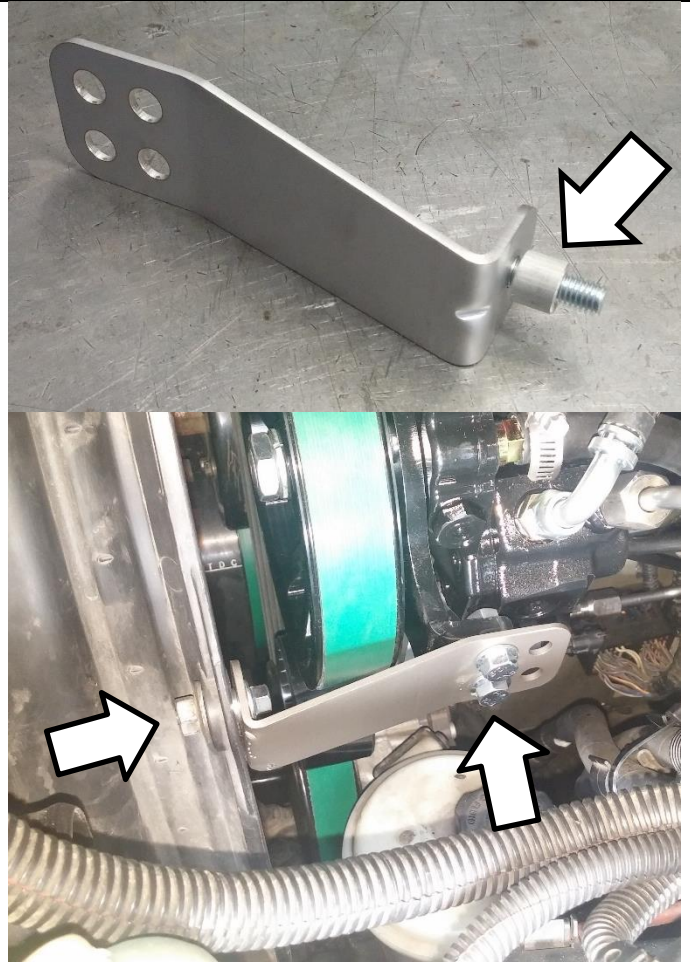

For 2010-2012 trucks:
The transmission cooler lines may run close to the CP3 pulley. Use the supplied insulated loop clamp and M8x20mm bolt to secure the rubber portion of the cooler line to the side of the CP3 bracket.

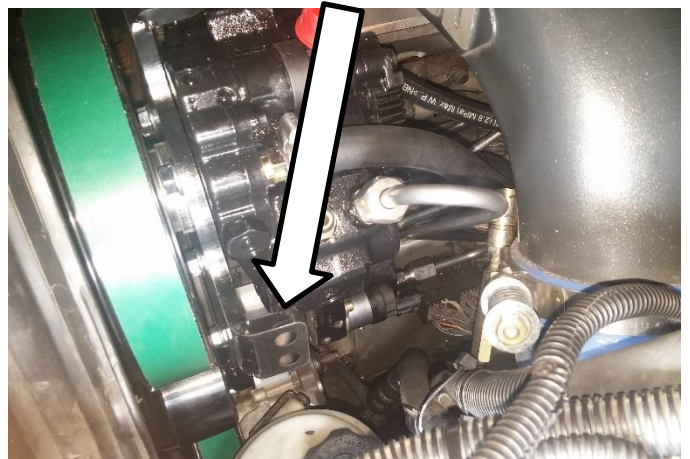

Install supplied upper radiator hose using the factory clamps.

Use the supplied P-clamp to support the hose above the pulley. Bolt the clamp to the CP3 bracket using the supplied M8x20mm bolt.

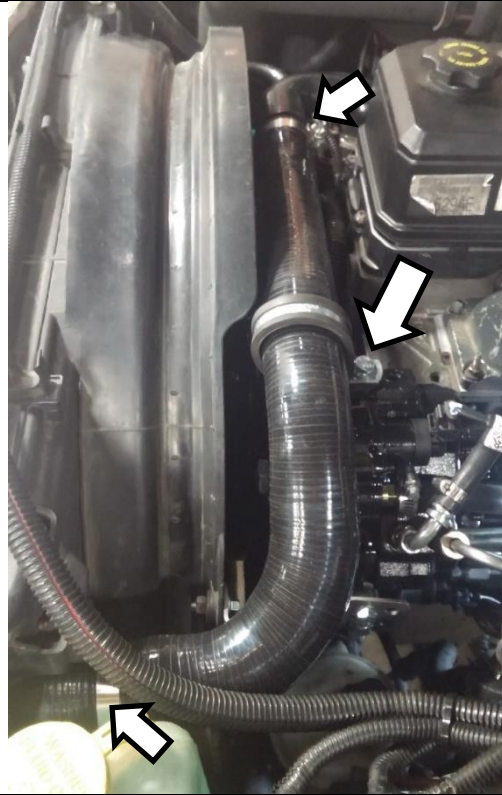

If the kit contains 1500722 - CP3 'Y' Harness follow the below steps.

If the kit contains 1050455 - Dual CP3 Controller, skip down to labeled section.

***For kits containing
1500722 – CP3 ‘Y’
Harness***



Disconnect the factory wiring harness from the original CP3 pump.

Using the “Y” end of the supplied harness, plug it into the factory wiring, and onto the original CP3 pump’s metering unit as shown.

Note Tuning is required when using the supplied “Y” harness. Incorrect tuning can cause premature failure of the high-pressure fuel system.



Route the supplied harness up to the second CP3 pump and plug it into the pumps metering unit.

Note Route the wire away from moving or hot components in the engine bay.

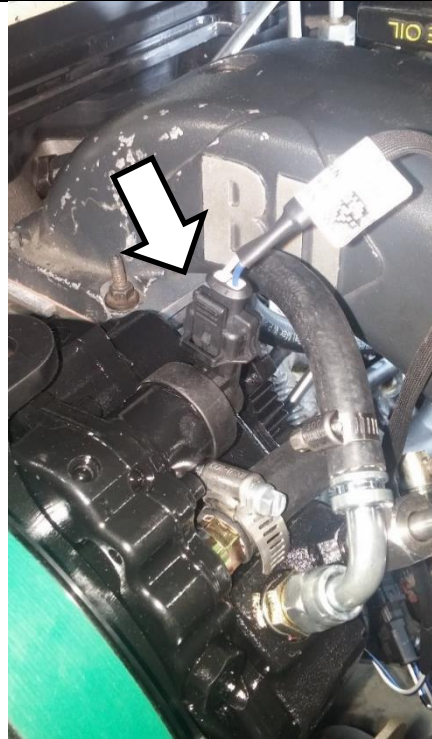

Double check to ensure all fittings are tight, then refill the truck with coolant and reconnect the batteries.

Ensure tuning is updated to run dual high-pressure fuel pumps, and prime fuel system by cycling ignition to allow the lift pump to run. Start engine and check for any fuel leaks.

***For kits containing
1050455 – Dual CP3
Control Module***



Unplug factory CP3 harness from CP3, and plug harness in between factory harness and CP3 Pump.

NOTE: See diagram at the end of this manual for connection details.

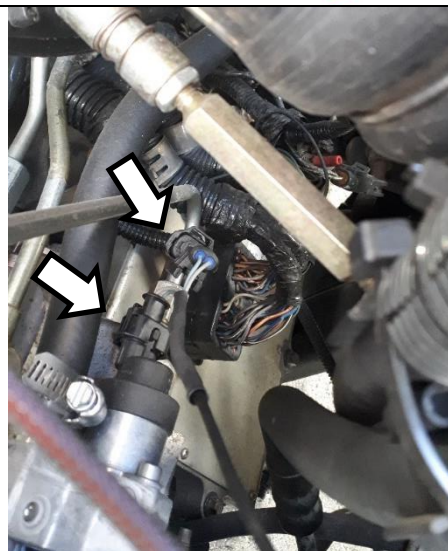

Plug harness into second CP3 pump.

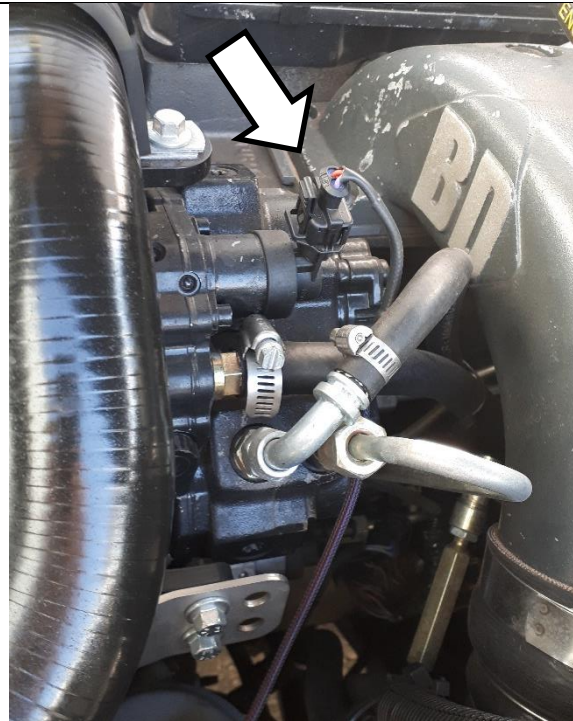

Mount controller in a safe area in the engine bay away from heat sources or belts and pulleys.

NOTE: Inner fender beside fuse box is a good spot for mounting, as it allows for easy connection to power sources.



Connect the ground wire (black) to a reliable ground source using supplied ring terminal.

NOTE: Ground stud works best (as shown).



Attach the Red wire to a constant 12v source.
 The constant power stud on fuse box works best.



NOTE: If you attach the power to a switched source, it could cause rail pressure spikes when the engine is turned off.



Secure wires away from heat sources, pulleys, or belts.

Double check to ensure all fittings are tight, then refill the truck with coolant and reconnect the batteries.

Prime fuel system by cycling ignition to allow the lift pump to run.
 Start engine and check for any fuel leaks.

Troubleshooting

High-pressure line leaks diesel fuel at fitting.	Ensure there is no debris or damage to the fitting cone surfaces, and ensure the joint is torqued to specification.
Rattle, or surging while engine running.	<p>For ‘Y’ Harness: Incorrect Tuning. Ensure tuning in truck has been adjusted for dual CP3 pumps.</p> <p>For Controller: Ensure control box is properly connected to a 12v power source, solidly grounded, and plugged in. If controller connection is confirmed, and problem persists, FCA (metering unit) should be inspected for proper operation on both CP3 pumps on vehicle.</p>
High CP3 Pump temperature	<p>For ‘Y’ Harness: Incorrect Tuning. Ensure tuning in truck has been adjusted for dual CP3 pumps.</p> <p>For Controller: Ensure control box is properly connected to a 12v power source, and solidly grounded. Also ensure plugs are fully connected on CP3 pumps.</p>

Kit Layout & Wiring Diagrams

